

# JVC

# SERVICE MANUAL

## COLOR TELEVISION

BASIC CHASSIS
AC

# AV-27D502 /R

# AV-27D502 /S

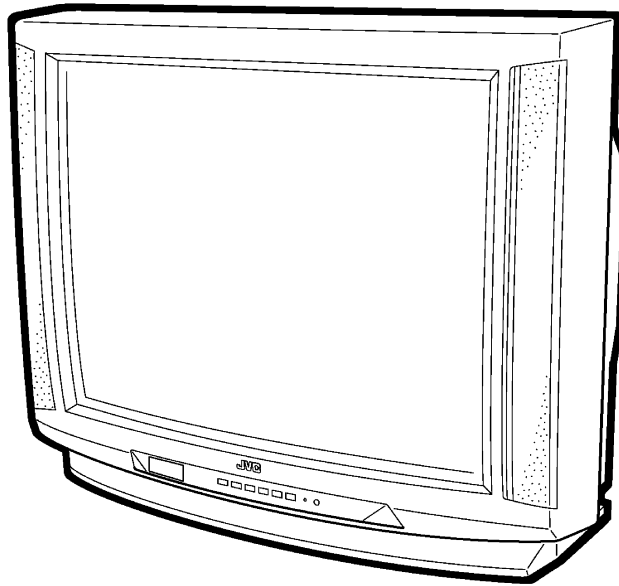
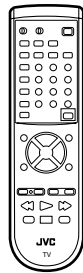

## CONTENTS

- SPECIFICATIONS .....2
- SAFETY PRECAUTIONS .....3
- FEATURES .....5
- MAIN DIFFERENCE LIST .....6
- HOW TO IDENTIFY MODELS .....6
- FUNCTIONS .....7
- SPECIFIC SERVICE INSTRUCTIONS .....8
- SERVICE ADJUSTMENTS .....12
- ★ STANDARD CIRCUIT DIAGRAM (APPENDIX) ..... 2-1
- PARTS LIST .....31

# SPECIFICATIONS

Items	Contents
<b>Dimensions (W × H × D)</b>	29-5/8" × 23-1/4" × 19-1/2" / 75.2cm × 59.1cm × 49.4cm
<b>Mass</b>	71.3 lbs/32.4kg
<b>TV RF System</b>	CCIR(M)
<b>Color Sound System</b>	NTSC, BTSC System (Multi Channel Sound)
<b>TV Receiving Channels and Frequency</b>	
<b>VL Band</b>	(02~06) 54MHz~88MHz
<b>VH Band</b>	(07~13) 174MHz~216MHz
<b>UHF Band</b>	(14~69) 470MHz~806MHz
<b>CATV Receiving Channels and Frequency</b>	
<b>Low Band</b>	(02~06, A-8) by (02~06&01)
<b>High Band</b>	(07~13) by (07~13)
<b>Mid Band</b>	(A~1) by (14~22)
<b>Super Band</b>	(J~W) by (23~36)
<b>Hyper Band</b>	(W+1~W+28) by (37~64)
<b>Ultra Band</b>	(W+29~W+84) by (65~125)
<b>Sub Mid Band</b>	(A8, A4~A1) by (01, 96~99)
<b>TV/CATV Total Channel</b>	180 Channels
<b>Intermediate Frequency</b>	
<b>Video IF Carrier</b>	45.75MHz
<b>Sound IF Carrier</b>	41.25MHz (4.5MHz)
<b>Color Sub Carrier</b>	3.58MHz
<b>Power Input</b>	120V AC, 60Hz
<b>Power Consumption</b>	123W
<b>Picture Tube</b>	27" (68cm) Measured Diagonally
<b>High Voltage</b>	29kV±1.3kV (at zero beam current)
<b>Speaker</b>	2" × 4-3/4" / 5 × 12cm Oval type × 2
<b>Audio Power Output</b>	5W × 2
<b>Video / Audio Input (1 / 2 / 3)</b>	Video(1,3) : 1Vp-p, 75Ω (RCA pin jack) Audio(1,2,3) : 500mVrms (-4dBs), High Impedance (RCA pin jack) S-Video ( Input 1 / 2 Over ) Y : 1Vp-p Positive (negative sync provided, when terminated with 75Ω) C : 0.286Vp-p (burst signal, when terminated with 75Ω) Component Input ( Input 2 ) Y : 1Vp-p positive (negative sync provided, when terminated with 75Ω) P <sub>B</sub> /P <sub>R</sub> : 0.7Vp-p 75 Ω
<b>Audio Output (Variable)</b>	Variable : More then 0~1550mVrms (+6dBs) Low impedance (400Hz when modulated 100%) (RCA pin jack)
<b>AV Compu link EX Input</b>	3.5mm mini jack
<b>Antenna terminal</b>	75Ω(VHF/UHF) Terminal, F-Type Connector
<b>Remote Control Unit</b>	RM-C301G-2A (AA/R6/UM-3 battery × 2)

*Design & specifications are subject to change without notice.*

# SAFETY PRECAUTIONS

- The design of this product contains special hardware, many circuits and components specially for safety purposes. For continued protection, no changes should be made to the original design unless authorized in writing by the manufacturer. Replacement parts must be identical to those used in the original circuits. Service should be performed by qualified personnel only.
- Alterations of the design or circuitry of the products should not be made. Any design alterations or additions will void the manufacturer's warranty and will further relieve the manufacturer of responsibility for personal injury or property damage resulting therefrom.
- Many electrical and mechanical parts in the products have special safety-related characteristics. These characteristics are often not evident from visual inspection nor can the protection afforded by them necessarily be obtained by using replacement components rated for higher voltage, wattage, etc. Replacement parts which have these special safety characteristics are identified in the parts list of Service manual. **Electrical components having such features are identified by shading on the schematics and by (  $\triangle$  ) on the parts list in Service manual.** The use of a substitute replacement which does not have the same safety characteristics as the recommended replacement part shown in the parts list of Service manual may cause shock, fire, or other hazards.
- Use isolation transformer when hot chassis.**  
The chassis and any sub-chassis contained in some products are connected to one side of the AC power line. An isolation transformer of adequate capacity should be inserted between the product and the AC power supply point while performing any service on some products when the HOT chassis is exposed.
- Don't short between the LIVE side ground and ISOLATED (NEUTRAL) side ground or EARTH side ground when repairing.**  
Some model's power circuit is partly different in the GND. The difference of the GND is shown by the LIVE : (  $\perp$  ) side GND, the ISOLATED(NEUTRAL) : (  $\parallel$  ) side GND and EARTH : (  $\oplus$  ) side GND. Don't short between the LIVE side GND and ISOLATED(NEUTRAL) side GND or EARTH side GND and never measure with a measuring apparatus (oscilloscope etc.) the LIVE side GND and ISOLATED(NEUTRAL) side GND or EARTH side GND at the same time.  
If above note will not be kept, a fuse or any parts will be broken.
- If any repair has been made to the chassis, it is recommended that the B1 setting should be checked or adjusted (See ADJUSTMENT OF B1 POWER SUPPLY).
- The high voltage applied to the picture tube must conform with that specified in Service manual. Excessive high voltage can cause an increase in X-Ray emission, arcing and possible component damage, therefore operation under excessive high voltage conditions should be kept to a minimum, or should be prevented. If severe arcing occurs, remove the AC power immediately and determine the cause by visual inspection (incorrect installation, cracked or melted high voltage harness, poor soldering, etc.). To maintain the proper minimum level of soft X-Ray emission, components in the high voltage circuitry including the picture tube must be the exact replacements or alternatives approved by the manufacturer of the complete product.
- Do not check high voltage by drawing an arc. Use a high voltage meter or a high voltage probe with a VTVM. Discharge the picture tube before attempting meter connection, by connecting a clip lead to the ground frame and connecting the other end of the lead through a 10k $\Omega$  2W resistor to the anode button.
- When service is required, observe the original lead dress. Extra precaution should be given to assure correct lead dress in the high voltage circuit area. Where a short circuit has occurred, those components that indicate evidence of overheating should be replaced. Always use the manufacturer's replacement components.

## 10. Isolation Check

### (Safety for Electrical Shock Hazard)

After re-assembling the product, always perform an isolation check on the exposed metal parts of the cabinet (antenna terminals, video/audio input and output terminals, Control knobs, metal cabinet, screwheads, earphone jack, control shafts, etc.) to be sure the product is safe to operate without danger of electrical shock.

#### (1) Dielectric Strength Test

The isolation between the AC primary circuit and all metal parts exposed to the user, particularly any exposed metal part having a return path to the chassis should withstand a voltage of 1100V AC (r.m.s.) for a period of one second.

(... Withstand a voltage of 1100V AC (r.m.s.) to an appliance rated up to 120V, and 3000V AC (r.m.s.) to an appliance rated 200V or more, for a period of one second.)

This method of test requires a test equipment not generally found in the service trade.

#### (2) Leakage Current Check

Plug the AC line cord directly into the AC outlet (do not use a line isolation transformer during this check.). Using a "Leakage Current Tester", measure the leakage current from each exposed metal part of the cabinet, particularly any exposed metal part having a return path to the chassis, to a known good earth ground (water pipe, etc.). Any leakage current must not exceed 0.5mA AC (r.m.s.).

However, in tropical area, this must not exceed 0.2mA AC (r.m.s.).

#### ● Alternate Check Method

Plug the AC line cord directly into the AC outlet (do not use a line isolation transformer during this check.). Use an AC voltmeter having 1000 ohms per volt or more sensitivity in the following manner. Connect a 1500 $\Omega$  10W resistor paralleled by a 0.15 $\mu$ F AC-type capacitor between an exposed metal part and a known good earth ground (water pipe, etc.). Measure the AC voltage across the resistor with the AC voltmeter. Move the resistor connection to each exposed metal part, particularly any exposed metal part having a return path to the chassis, and measure the AC voltage across the resistor. Now, reverse the plug in the AC outlet and repeat each measurement. Any voltage measured must not exceed 0.75V AC (r.m.s.). This corresponds to 0.5mA AC (r.m.s.).

However, in tropical area, this must not exceed 0.3V AC (r.m.s.). This corresponds to 0.2mA AC (r.m.s.).

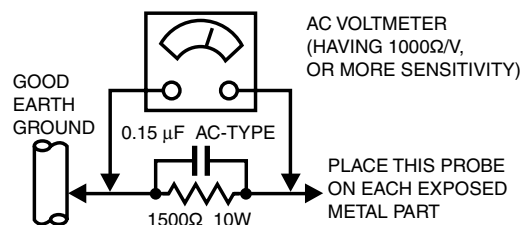

## 11. High voltage hold down circuit check.

After repair of the high voltage hold down circuit, this circuit shall be checked to operate correctly.

See item "How to check the high voltage hold down circuit".

This mark shows a fast operating fuse, the letters indicated below show the rating.



**POWER CORD REPLACEMENT WARNING**  
Connecting the white line side of power cord to "WHT" character side.

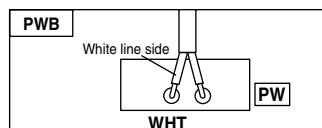

# REPLACEMENT OF CHIP COMPONENT

## ■ CAUTIONS

1. Avoid heating for more than 3 seconds.
2. Do not rub the electrodes and the resist parts of the pattern.
3. When removing a chip part, melt the solder adequately.
4. Do not reuse a chip part after removing it.

## ■ SOLDERING IRON

1. Use a high insulation soldering iron with a thin pointed end of it.
2. A 30w soldering iron is recommended for easily removing parts.

## ■ REPLACEMENT STEPS

### 1. How to remove Chip parts

#### ◆ Resistors, capacitors, etc.

- (1) As shown in the figure, push the part with tweezers and alternately melt the solder at each end.

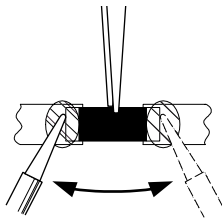

- (2) Shift with tweezers and remove the chip part.

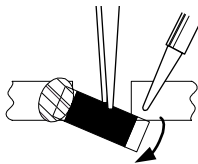

#### ◆ Transistors, diodes, variable resistors, etc.

- (1) Apply extra solder to each lead.

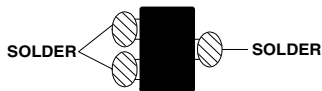

- (2) As shown in the figure, push the part with tweezers and alternately melt the solder at each lead. Shift and remove the chip part.

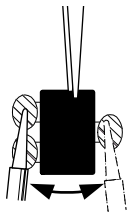

*Note : After removing the part, remove remaining solder from the pattern.*

### 2. How to install Chip parts

#### ◆ Resistors, capacitors, etc.

- (1) Apply solder to the pattern as indicated in the figure.

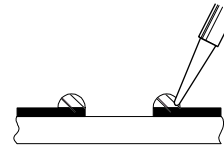

- (2) Grasp the chip part with tweezers and place it on the solder. Then heat and melt the solder at both ends of the chip part.

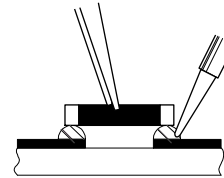

#### ◆ Transistors, diodes, variable resistors, etc.

- (1) Apply solder to the pattern as indicated in the figure.
- (2) Grasp the chip part with tweezers and place it on the solder.
- (3) First solder lead **A** as indicated in the figure.

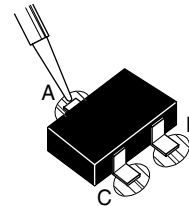

- (4) Then solder leads **B** and **C**.

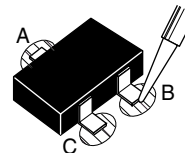

# FEATURES

- Full-square CRT (cathode ray tube) reproduces fine textured picture in every detail.
- I<sup>2</sup>C bus control utilizes single chip ICs.
- Built in Twin Tuner system.
- Built-in HYPER-SURROUND system.
- Built-in BBE.
- Adoption of the Picture-In-Picture (PIP) function.
- 3 LINE DIGITAL COMB FILTER circuit improved picture quality.
- Component input terminal for taking best advantage of Component Video Signal.
- Audio Video input terminal. (S-input x2, V-input x2)
- Variable audio output terminal.
- Closed-caption broadcasts can be viewed.
- With AV COMPU LINK EX terminal.

## ■ SYSTEM BLOCK DIAGRAM

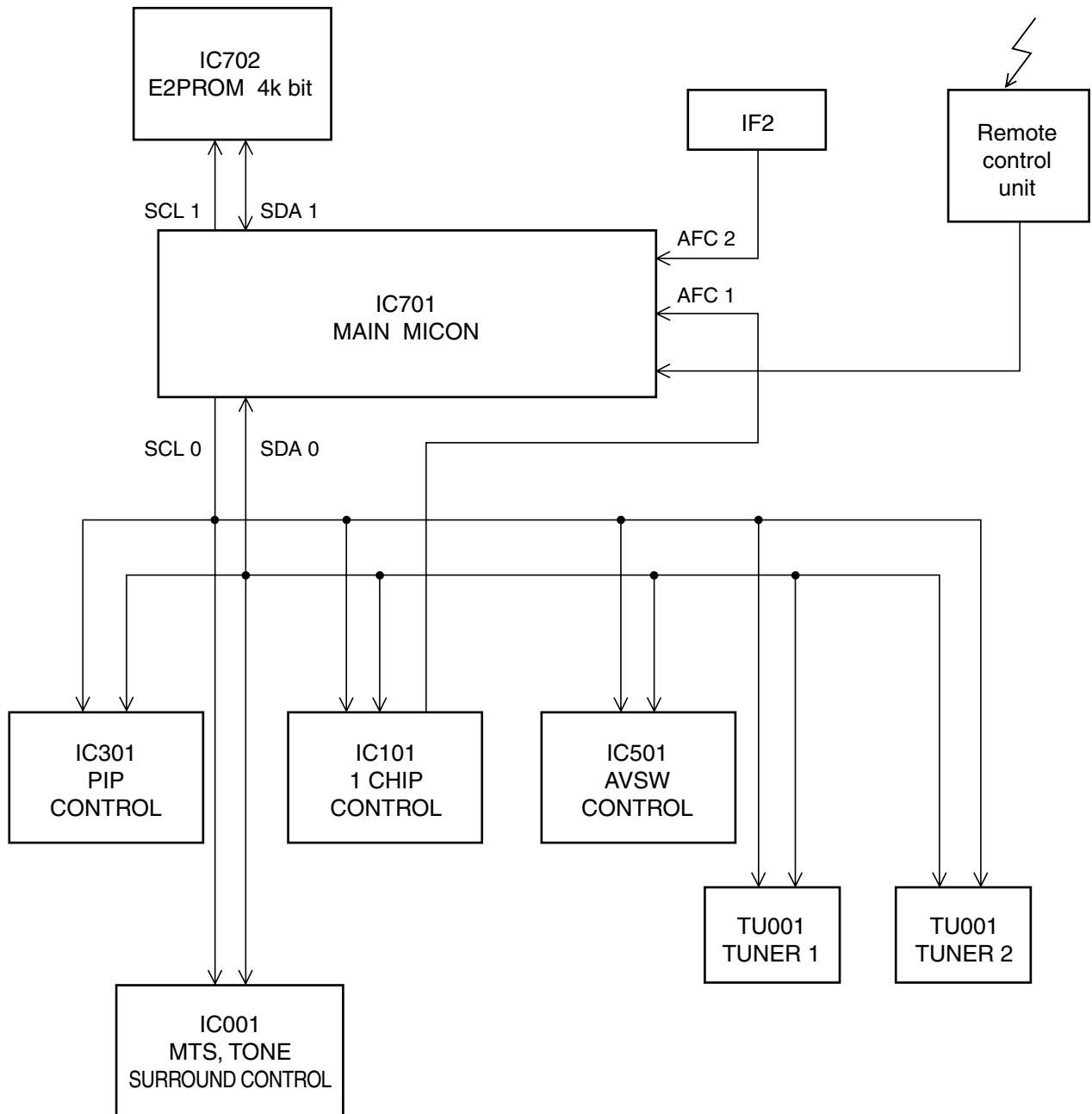

# MAIN DIFFERENCE LIST

△	Part name / Model	AV-27D502/R	AV-27D502/s
	MAIN PWB	SAC-1507A-M2	SAC-1506A-M2
	CRT SOCKET PWB	SAC-3507A-M2	SAC-3506A-M2
△	PICTURE TUBE	A68ADT25X01	A68QDN891X001

## HOW TO IDENTIFY MODELS

The difference between AV-27D502/R and AV-27D502/s is in the PICTURE TUBE.  
 As the result of the difference in PICTURE TUBE, the MAIN PWB also differ.

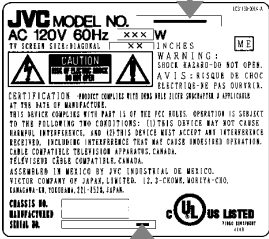
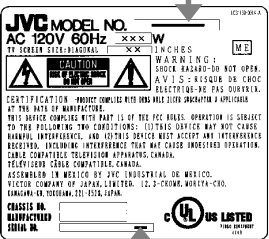
△	Part name / Model	AV-27D502/R	AV-27D502/s
△	RATING LABEL	<p>LC31139-001A-A</p> <p>INDICATED AV-27D502</p>  <p>INDICATED "R"</p>	<p>←</p> <p>INDICATED AV-27D502</p>  <p>INDICATED "S"</p>

# FUNCTIONS

## ■ FRONT PANEL

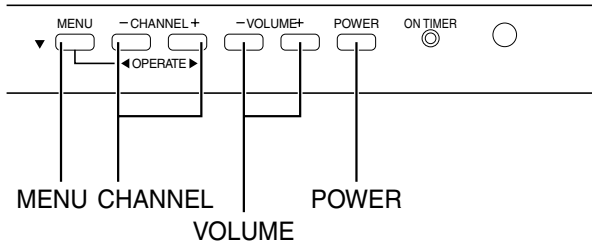

## ■ FRONT PANEL DOOR OPENED

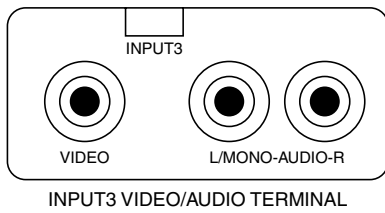

## ■ REAR PANEL

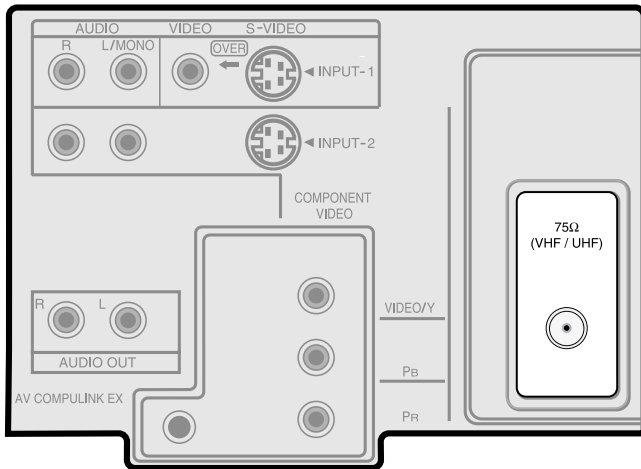

## ■ REMOTE CONTROL UNIT (RM-C301G-2A)

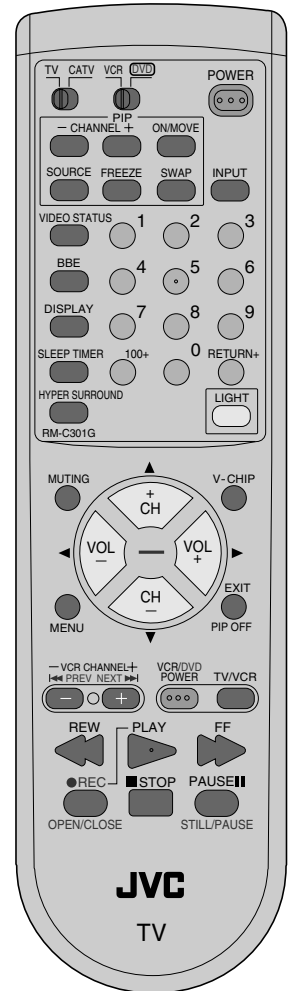

# SPECIFIC SERVICE INSTRUCTIONS

## DISASSEMBLY PROCEDURE

### REMOVING THE REAR COVER

1. Unplug the power supply cord.
2. Remove the 12 screws marked (A) as shown in Fig.1.
3. Withdraw the REAR COVER toward you.

#### [CAUTION]

- When reinstalling the rear cover, carefully push it inward after inserting the MAIN PWB into the rear cover groove.

### REMOVING THE CHASSIS

- After removing the rear cover.
1. Slightly raise the both sides of the chassis by hand and remove the 3 claws marked (B) under the chassis from the front cabinet as shown in Fig.1.
  2. Withdraw the chassis backward along the rail in the arrow direction marked (C) as shown in Fig.1.

(If necessary, take off the wire clamp, connector's etc.)

\* When conducting a check with power supplied, be sure to confirm that the CRT earth wire is connected to the CRT SOCKET PWB and the MAIN PWB.

### REMOVING THE TERMINAL BOARD

- After removing the rear cover.
1. Remove the 4 screws marked (D) as shown in Fig.1.
  2. When you pull out the TERMINAL BOARD in the direction of arrow marked (E) as shown in Fig.1, it can be removed.

### REMOVING THE FRONT CONTROL AND FRONT AV INPUT PW BOARDS

- After removing the rear cover and chassis.
1. Remove the 3 screws marked (F) and the 2 screws marked (J) as shown in Fig.1.
  2. Then remove the FRONT CONTROL PWB and FRONT AV INPUT PWB.

(If necessary, take off the wire, connector's etc.)

### REMOVING THE LF PW BOARD

- After removing the rear cover and chassis.
1. Lift the left side of the LF PWB while pressing the 2 PWB stoppers marked (G) in the arrow direction marked (H) as shown in Fig.1.
  2. Then remove the LF PWB.

(If necessary, take off the wire, connector's etc.)

### REMOVING THE SPEAKER

- After removing the rear cover.
1. Remove the 4 screws marked (K) as shown in Fig.1.
  2. Withdraw the speaker backward.
  3. Follow the same steps when removing the other hand speaker.

### CHECKING THE MAIN PW BOARD

1. To check the back side of the MAIN PW Board.
  - 1) Pull out the chassis. (Refer to REMOVING THE CHASSIS).
  - 2) Erect the chassis vertically so that you can easily check the back side of the MAIN PW Board.

#### [CAUTION]

- When erecting the chassis, be careful so that there will be no contacting with other PW Board.
- Before turning on power, make sure that the CRT earth wire and other connectors are properly connected.

### WIRE CLAMPING AND CABLE TYING

1. Be sure clamp the wire.
2. Never remove the cable tie used for tying the wires together. Should it be inadvertently removed, be sure to tie the wires with a new cable tie.



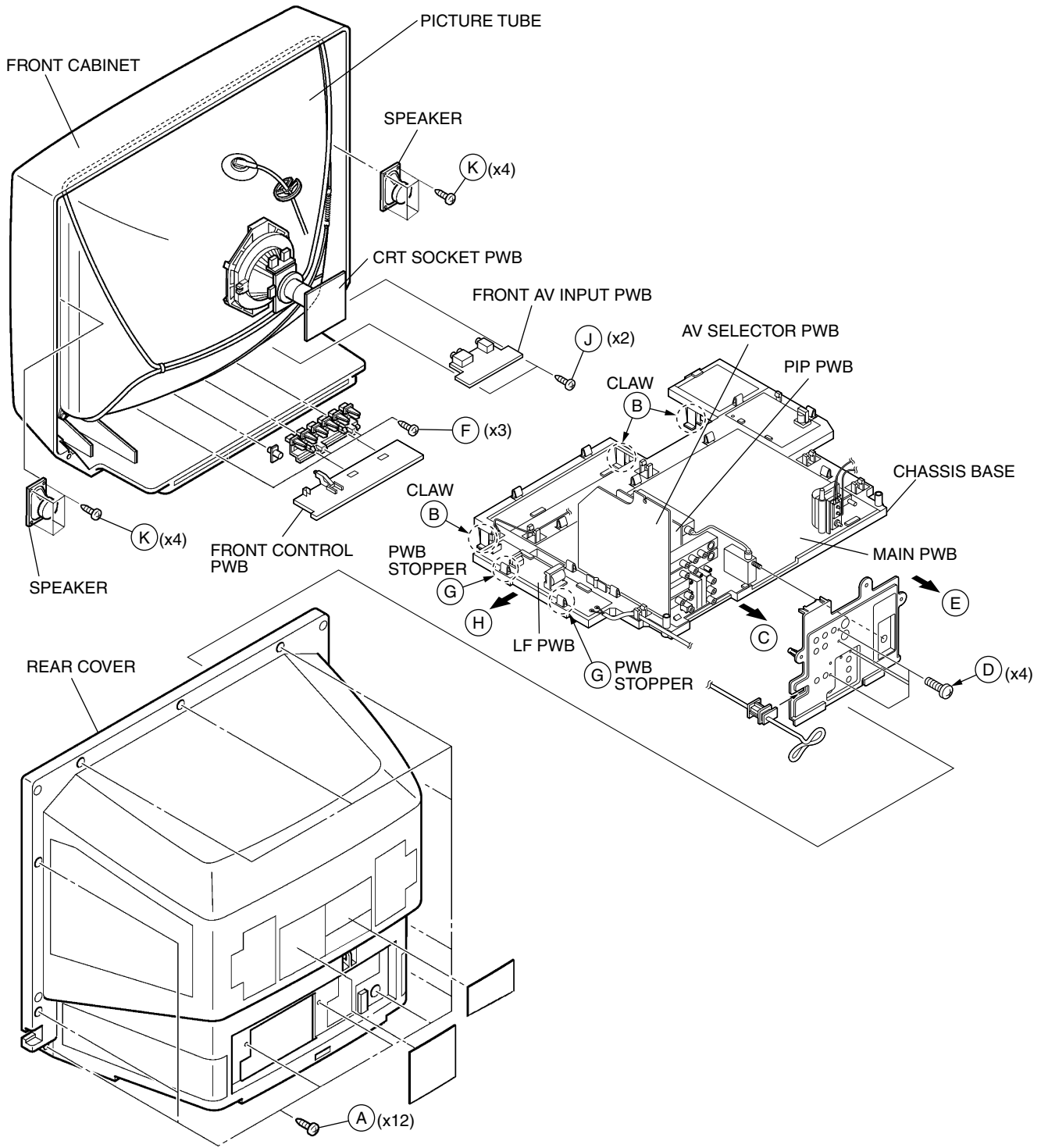

Fig.1

# MEMORY IC REPLACEMENT

## 1. Memory IC

This model use a memory IC.  
 This memory IC stores data for proper operation of the video and deflection circuits.  
 When replacing, be sure to use an IC containing this (initial value) data.

## 2. Memory IC replacement procedure

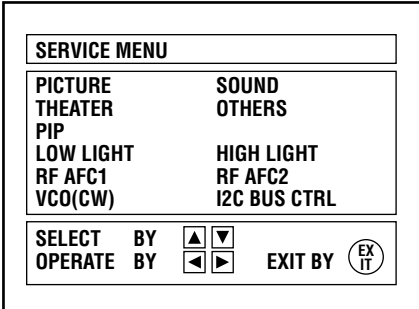
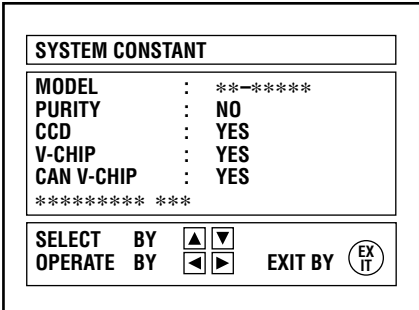
Procedure	Screen display
<p><b>(1) Power off</b>                      Switch off the power and disconnect the power cord from the outlet.</p>	
<p><b>(2) Replace the memory IC</b>                      Initial value must be entered into the new IC.</p>	
<p><b>(3) Power on</b>                      Connect the power cord to the outlet and switch on the power.</p>	
<p><b>(4) System constant check and setting</b></p> <ol style="list-style-type: none"> <li>1) Press <b>SLEEP TIMER</b> key and, while the indication of “<b>SLEEP TIMER 0 MIN.</b>” is being displayed, press <b>DISPLAY</b> key and <b>VIDEO STATUS</b> key on the remote control unit simultaneously.</li> <li>2) The SERVICE MENU screen of Fig.1 is displayed.</li> <li>3) While the SERVICE MENU is displayed, again simultaneously press the DISPLAY and VIDEO STATUS keys to display the Fig.2 SYSTEM CONSTANT screen.</li> <li>4) Refer to the SYSTEM CONSTANT table and check the setting items. Where these differ, select the setting item with the MENU UP/DOWN key and adjust the setting with the MENU LEFT/RIGHT keys. (The letters of the selected item are displayed in yellow.)</li> <li>5) After adjusting, release the MENU LEFT/RIGHT key to store the setting value.</li> <li>6) Press the EXIT key twice to return the normal screen.</li> </ol>	 <p style="text-align: center;">Fig.1</p>
<p><b>(5) Receive channel setting</b>                      Refer to the OPERATING INSTRUCTIONS(USER'S GUIDE) and set the receive channels (Channels Preset) as described.</p>	
<p><b>(6) User settings</b>                      Check the user setting items according to Table 2.                      Where these do not agree, refer to the OPERATING INSTRUCTIONS (USER'S GUIDE) and set the items as described.</p>	 <p style="text-align: center;">Fig.2</p>
<p><b>(7) SERVICE MENU setting</b>                      Verify what to set in the SERVICE MENU, and set whatever is necessary.(Fig.1) Refer to the SERVICE ADJUSTMENT for setting.</p>	

**TABLE 1 (System Constant setting)**

Setting item	Setting content	Setting value
MODEL		AV-27D502
PURITY	<input type="checkbox"/> → YES → NO <input type="checkbox"/>	NO
CCD	<input type="checkbox"/> → YES → NO <input type="checkbox"/>	YES
V-CHIP	<input type="checkbox"/> → YES → NO <input type="checkbox"/>	YES
CAN V-CHIP	<input type="checkbox"/> → YES → NO <input type="checkbox"/>	YES

**TABLE 2 (User setting value)**

Setting item	Setting value
<b>1. Use remote controller keys</b>	
POWER	OFF
CHANNEL	CH-02
VOLUME	5
INPUT	TV
HYPERSURROUND	OFF
BBE	ON
DISPLAY	OFF
SLEEP TIMER	0
VIDEO STATUS	CHOICE
PIP SOURCE	CH-04
PIP ON (PIP POSITION)	LEFT LOWR SIDE
<b>2. Setting of MENU</b>	
<b>PICTURE ADJUST</b>	
TINT	CENTER
COLOR	CENTER
PICTURE	CENTER
BRIGHT	CENTER
DETAIL	CENTER
NOISE MUTING	ON
SET VIDEO STATUS	ALL CENTER
<b>SOUND ADJUST</b>	
BASS	CENTER
TREBLE	CENTER
BALANCE	CENTER
MTS	STEREO
<b>CLOCK/TIMERS</b>	
SET CLOCK	Unnecessary to set
ON/OFF TIMER	NO
<b>INITIAL SETUP</b>	
TV SPEAKER	ON
COMPONENT-IN	NO
LANGUAGE	ENG
CLOSED CAPTION	OFF
AUTO TUNER SETUP	TUNER MODE: AIR
CHANNEL SUMMARY	Unnecessary to set
V-CHIP	OFF
SET LOCK CODE	Unnecessary to set

# SERVICE ADJUSTMENTS

## ADJUSTMENT PREPARATION:

1. You can make the necessary adjustments for this unit with either the remote control unit or with the adjustment equipment and parts as given below.
2. Adjustment with the remote control unit is made on the basis of the initial setting values, however, the new setting values which set the screen to its optimum condition may differ from the initial settings.
3. Make sure that AC power is turned on correctly.
4. Turn on the power for the set and test equipment before use, and start the adjustment procedures after waiting at least 30 minutes.
5. Unless otherwise specified, prepare the most suitable reception or input signal for adjustment.
6. Never touch any adjustment parts, which are not specified in the list for this adjustment-variable resistors, transformers, capacitors, etc.
7. Presetting before adjustment.

Unless otherwise specified in the adjustment instructions, preset the following functions with the remote control unit.

- User mode setting position

VIDEO STATUS	STANDARD
HYPERSURROUND	OFF
BASS, TREBLE, BALANCE	CENTER
TINT, COLOR, PICTURE, BRIGHT, DETAIL	CENTER

## MEASURING INSTRUMENT

1. DC voltmeter(or digital voltmeter)
2. Oscilloscope
3. Signal generator ( Pattern generator ) [NTSC]
4. Remote control unit
5. TV audio multiplex signal generator
6. Frequency counter
7. Resistor (1M $\Omega$ )

## ADJUSTMENT ITEMS

- Check of B1 POWER SUPPLY
- RF AGC adjustment
- FOCUS adjustment
- WHITE BALANCE adjustment
  - WHITE BALANCE (Low Light) adjustment
  - WHITE BALANCE (High Light) adjustment
  - PIP HIGH LIGHT WHITE BALANCE Adjustment
- BRIGHT adjustment
  - SUB BRIGHT adjustment
- CONTRAST adjustment
  - SUB CONTRAST adjustment
- DEFLECTION adjustment
  - V CENTER and TRAPEZIUM adjustment
  - V-SIZE and V-LINEARITY adjustment
  - H POSITION adjustment
  - PIP DISPLAY POSITION adjustment
- CHROMA adjustment
  - SUB COLOR adjustment
  - SUB TINT adjustment
- MTS circuit adjustment
  - INPUT LEVEL check
  - STEREO VCO adjustment
  - SAP VCO adjustment
  - FILTER check
  - SEPARATION adjustment

# ADJUSTMENT LOCATIONS

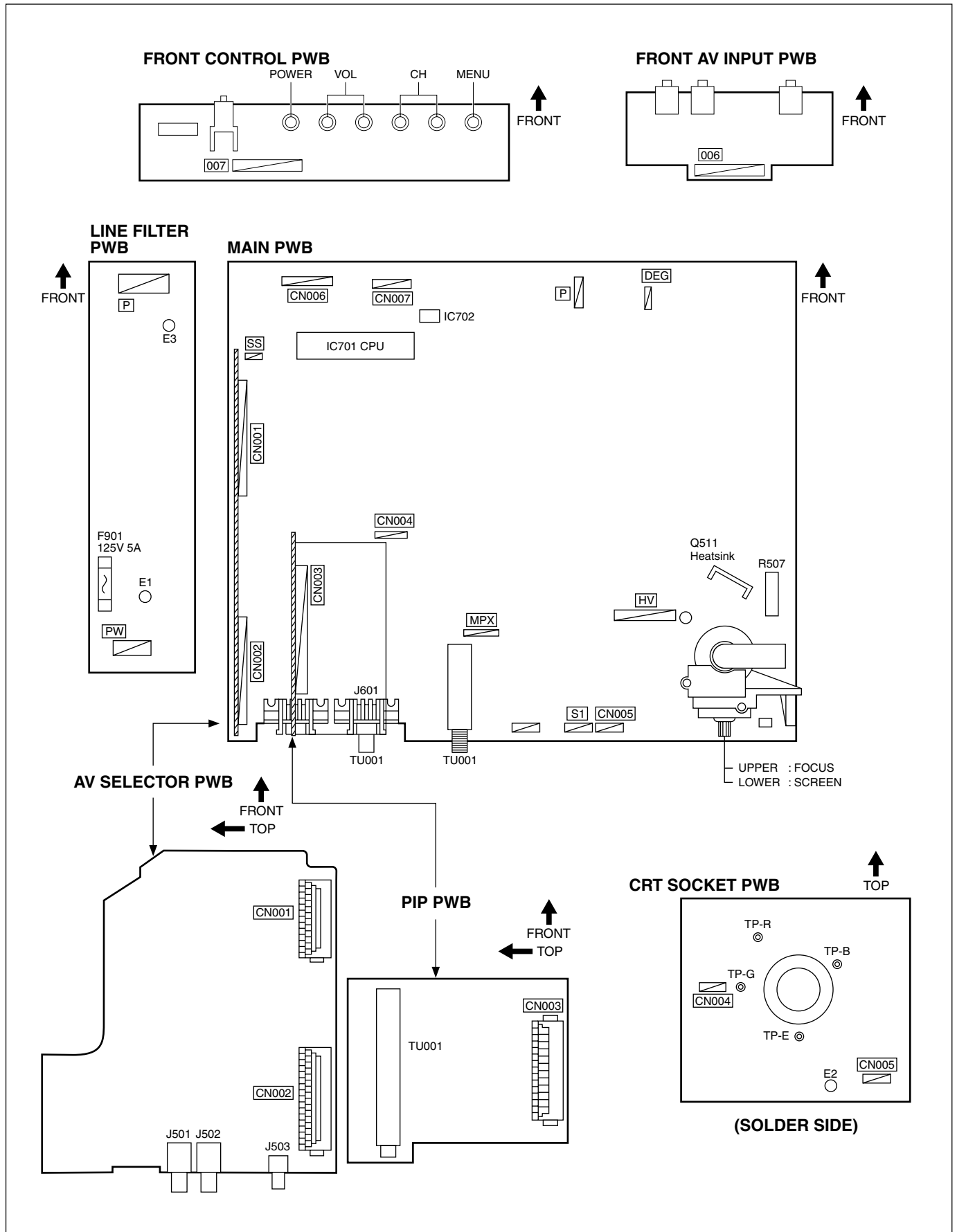

# BASIC OPERATION OF SERVICE MENU

## 1. TOOL OF SERVICE MENU OPERATION

Operate the SERVICE MENU with the REMOTE CONTROL UNIT.

## 2. SERVICE MENU ITEMS

In general, basic setting (adjustments) items or verifications are performed in the SERVICE MENU.

- PICTURE ..... This sets the setting values (adjustment values) of the VIDEO/CHROMA and DEFLECTION circuits.
- SOUND ..... This sets the setting values (adjustment values) of the AUDIO circuit.
- THEATER ..... This is used when the THEATER MODE is adjusted.
- OTHERS ..... This is used when the OTHERS MODE is adjustment.
- PIP ..... This sets the setting values (adjustment values) of the PIP circuit.
- LOW LIGHT ..... This sets the setting values (adjustment values) of the WHITE BALANCE circuit.
- HIGH LIGHT ..... This sets the setting values (adjustment values) of the WHITE BALANCE circuit.
- RF AFC1 ..... This is used when the RF AFC1 MODE is verified. **[Do not adjust]**
- RF AFC2 ..... This is used when the RF AFC2 MODE is verified. **[Do not adjust]**
- VCO (CW) ..... This is not used for service.
- I2C BUS CTRL ..... This is used when ON/OFF of the I2C BUS CTRL is set. **[Fixed ON]**

## 3. Basic Operations of the SERVICE MENU

### (1) How to enter the SERVICE MENU.

Press **SLEEP TIMER** key and, while the indication of "SLEEP TIMER 0 MIN." is being displayed, press **DISPLAY** key and **VIDEO STATUS** key on the remote control unit simultaneously to enter the **SERVICE MENU** screen ① shown in the next figure page.

### (2) SERVICE MENU screen selection

Press the UP / DOWN key of the MENU to select any of the following items.

(The letters of the selected items are displayed in yellow.)

- |             |                |
|-------------|----------------|
| ● PICTURE   | ● SOUND        |
| ● THEATER   | ● OTHERS       |
| ● PIP       |                |
| ● LOW LIGHT | ● HIGH LIGHT   |
| ● RF AFC1   | ● RF AFC2      |
| ● VCO(CW)   | ● I2C BUS CTRL |

### (3) Enter the any setting ( adjustment ) mode

#### ● PICTURE, SOUND and OTHERS mode

- 1) If select any of PICTURE, SOUND or OTHERS items, and the LEFT / RIGHT key is pressed from SERVICE MENU ( MAIN MENU ), the screen ② will be displayed as shown in figure page later.
- 2) Then the UP / DOWN key is pressed, the PICTURE mode screen ③ or the SOUND mode screen ④ or the OTHER mode screen ⑤ is displayed, and the PICTURE, SOUND or OTHERS setting can be performed.

#### ● PIP mode

- 1) If select the PIP item, and the LEFT/RIGHT key is pressed from SERVICE MENU (MAIN MENU), the screen ⑥ will be displayed as shown in figure page later.
- 2) Then the UP/DOWN key is pressed, the PIP mode screen ⑦ is displayed, and the PIP setting can be performed.

#### ● THEATER, LOW LIGHT, HIGH LIGHT, RF AFC1, RF AFC2, VCO(CW) and I2C BUS CTRL mode

- 1) If select any of THEATER / LOW LIGHT / HIGH LIGHT / RF AFC1 / RF AFC2 / VCO (CW) / I2C BUS CTRL items, and the LEFT / RIGHT key is pressed from SERVICE MENU ( MAIN MENU ), the screens ⑧ ⑨ ⑩ ⑪ ⑫ ⑬ ⑭ will be displayed as shown in figure page later.
- 2) Then the settings or verifications can be performed.

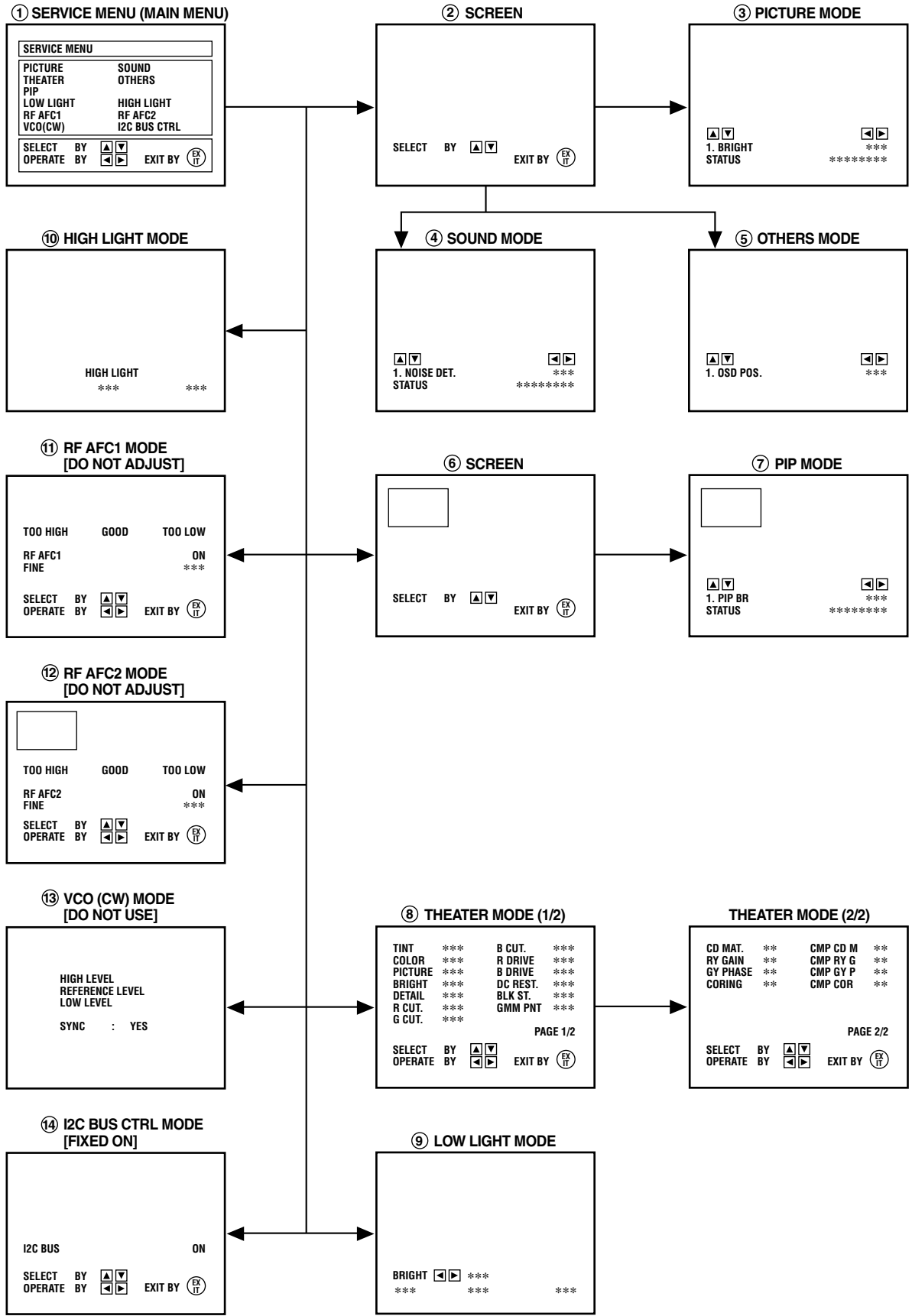

**(4) Setting method**

- 1) UP / DOWN key of the MENU  
Select the SETTING ITEM.
- 2) LEFT / RIGHT key of the MENU  
Setting (adjust) the SETTING VALUE of the SETTING ITEM.  
When the key is released the SETTING VALUE will be stored (memorized).
- 3) EXIT key  
Returns to the previous screen.

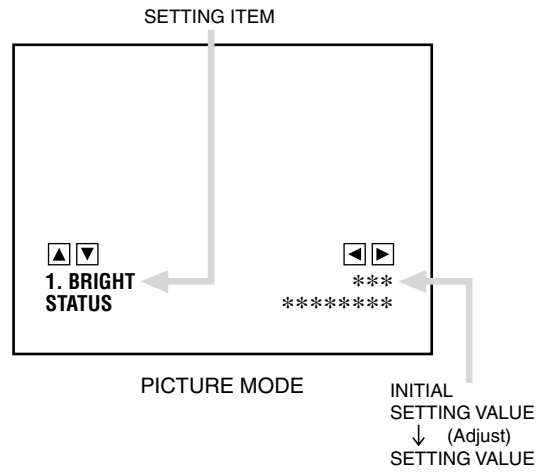

**(5) Releasing SERVICE MENU**

- 1) After returning to the SERVICE MENU upon completion of the setting (adjustment) work, press the EXIT key again.

★ The settings for LOW LIGHT and HIGH LIGHT are described in the WHITE BALANCE page of ADJUSTMENT.



## INITIAL SETTING VALUE OF SERVICE MENU

1. Adjustment of the SERVICE MENU is made on the basis of the initial setting values; however, the new setting values which set the screen in its optimum condition may differ from the initial setting.
2. Do not change the initial setting values of the setting (Adjustment) items not listed in "ADJUSTMENT".

### ● PICTURE MODE

☆ The four setting items in the video mode No.6 EXT BRI., No.7 EXT PIC., No.8 EXT COL. and No.9 EXT TINT are linked to the items in the TV MODE No.1 BRIGHT, No.2 PICTURE, No.3 COLOR and No.4 TINT, respectively. When the setting items in the TV mode are adjusted, the values in the setting items in the video mode are revised automatically to the same values in the TV mode.(The initial setting values given in ( ) are off-set values.)

☆ When the four items (No.6, 7, 8 and 9) are adjusted in the video mode, the setting values in each item are revised independently.

No.	Setting (Adjustment) item	Variable range	Initial setting value
1	BRIGHT	000 — 127	063
2	PICTURE	000 — 127	080
3	COLOR	000 — 127	072
4	TINT	000 — 127	065
5	TV DETAIL	000 — 063	045
6	EXT BRIGHT	±025	±001
7	EXT PICT.	±025	±002
8	EXT COLOR	±025	±002
9	EXT TINT	±025	-004
10	EXT DETAIL	000 — 063	045
11	CMP BRIGHT	±025	-003
12	CMP PICT.	±025	+006
13	CMP COLOR	000 — 127	080
14	CMP TINT	000 — 127	068
15	CMP DETAIL	000 — 063	050
16	CMP R CUT	±025	-011
17	CMP G CUT	±025	±000
18	CMP B CUT	±025	-001
19	CMP R DRV	±025	±000
20	CMP B DRV	±025	±000
21	WPL	000 / 001	001
22	B. B. SW	000 / 001	000
23	C TRAP	000 / 001	000
24	CORING	000 / 001	000
25	CMP CORING	000 / 001	001
26	TV SHARPF	000 / 001	001
27	EXT SHARPF	000 / 001	001
28	CMP SHARPF	000 / 001	001
29	RGB CONT	000 — 063	031
30	TV ID SENS	000 / 001	000
31	EXT ID SEN	000 / 001	001
32	F ID	000 / 001	000
33	Y MUTE	000 / 001	000
34	AUDIO ATT	000 — 127	127
35	SUB CONT	000 — 015	008

No.	Setting (Adjustment) item	Variable range	Initial setting value
36	R Y GAIN	000 / 001	001
37	CMP R Y GA	000 / 001	001
38	G Y PHASE	000 / 001	000
39	CMP G Y PH	000 / 001	000
40	CD MATRIX	000 — 003	003
41	CMP CD MAT	000 — 003	002
42	BLACK ST	000 — 003	001
43	DC REST	000 — 003	001
44	COLOR GMM	000 / 001	000
45	UV/CBCR	000 / 001	001
46	AT FLESH	000 / 001	000
47	ABL GAIN	000 — 003	000
48	ABL ST PNT	000 — 003	003
49	RGB ABCL	000 / 001	001
50	TV BPF TOF	000 / 001	000
51	EXT BPF TOF	000 / 001	000
52	GMM PNT	000 — 003	003
53	SVM GAIN	000 — 003	003
54	CMP SVM GA	000 — 003	003
55	SVM PHASE	000 / 001	000
56	AUDIO SW	000 / 001	000
57	BUZZ	000 / 001	000
58	IF FREQ	000 / 001	000
59	RF AGC	000 — 063	045
60	AFT MUTE	000 / 001	000
61	AFT SENS	000 / 001	001
62	R/G DRV SW	000 / 001	001
63	BLK SW	000 / 001	000
64	V S COR	000 — 015	012
65	V LIN	000 — 015	007
66	V SIZE	000 — 127	074
67	V AGC	000 / 001	000
68	V CENTER	000 — 063	053
69	TV AFC	000 — 003	000
70	EXT AFC	000 — 003	002
71	V POSI	000 — 007	000
72	H POSI	000 — 031	016
73	H SIZE	000 — 063	023
74	TV V FREQ	000 — 003	000
75	EXT V FREQ	000 — 003	003
76	SIDE PIN	000 — 063	027
77	STAND BY	000 / 001	000
78	TRAPEZ	000 — 063	035
79	V RAMP REF	000 / 001	001
80	V 48HZ	000 / 001	000
81	V EHT	000 — 007	000
82	TOP PIN	000 — 031	010

No.	Setting (Adjustment) item	Variable range	Initial setting value
83	H EHT	000 — 007	000
84	BTM PIN	000 — 031	012
85	V BLK LOW	000 — 003	000
86	V BLK UP	000 — 003	000
87	CAPTION IN	000 / 001	000
88	H BLK	000 / 001	000
89	SCREEN	000 / 001	000
90	ACB SW	000 / 001	000
91	ACB PULSE	000 — 015	007
92	OVER MODU	000 / 001	001
93	APACON LIM	000 / 001	001
94	TEST	000 — 255	128
95	RF S/N TY	000 — 002	002
96	EXT S/N TY	000 — 002	002
97	RF SN YC E	000 — 255	005
98	RF SN YC F	000 — 255	016
99	RF SN YC G	000 — 063	032
100	RF SN YC H	000 — 255	025
101	EX SN YC E	000 — 255	005
102	EX SN YC F	000 — 255	016
103	EX SN YC G	000 — 063	032
104	EX SN YC H	000 — 255	025
105	RF SN VC 1	000 — 063	000
106	RF SN VC 2	000 — 063	007
107	RF SN VC 3	000 — 063	014
108	RF SN VC 4	000 — 063	021
109	EX SN VC 1	000 — 063	000
110	EX SN VC 2	000 — 063	007
111	EX SN VC 3	000 — 063	014
112	EX SN VC 4	000 — 063	021
113	COR LEVEL	000 — 003	003
114	VNR CHK	000 — 255	003
115	YC SN TIME	000 — 255	005
116	VC SN TIME	000 — 255	005
117	VM DATA A	±127	+008
118	VM DATA B	±127	-004
119	VM DATA C	±127	-016
120	VM DATA D	000 / 001	000
121	VC SN STOP	000 — 255	010
122	CH MUTE	00/001	000
123	VM OFF TY	000/001	000
124	VC VM OFF	000/001	001
125	YC VM OFF	000 — 255	255
126	F LOCK	000 — 002	002
127	VF LOCK EX	000/001	000
128	PURI RGB	000 — 063	031
129	PURI BCK	000/001	000

## ● SOUND MODE

No.	Setting (Adjustment) item	Variable range	Initial setting value
1	NOISE DET.	000 / 001	001
2	IN LEVEL	000 — 063	025
3	FH MONITOR	000 / 001	000
4	STEREO VCO	000 — 063	030
5	PILOT CAN.	000 / 001	000
6	FILTER	000 — 063	030
7	LOW SEP.	000 — 063	028
8	HI SEP.	000 — 063	025
9	5FH MON.	000 / 001	000
10	SAP VCO	000 — 063	003
11	IN GAIN	000 / 001	000
12	FIL. OFFSET	±010	±000
13	BBE BASS	±010	+003
14	BBE TRE	±010	+003

## ● THEATER MODE

Setting (Adjustment) item	Variable range	Initial setting value
TINT	±20	-06
COLOR	±20	-03
PICTURE	±50	-15
BRIGHT	±20	±00
DETAIL	±20	+03
R CUT.	±20	±00
G CUT.	±20	±00
B CUT.	±20	±00
R DRIVE	±99	+07
B DRIVE	±99	-25
DC REST.	00 — 03	01
BLK ST.	00 — 03	00
GMM PNT	00 — 03	01
CD MATRIX	00 — 03	01
RY GAIN	00 / 01	01
GY PHASE	00 / 01	00
CORING	00 / 01	01
CMP CD M	00 — 03	01
CMP RY G	00 / 01	01
CMP GY P	00 / 01	00
CMP COR	00 / 01	01

● OTHERS MODE

No.	Setting (Adjustment) item	Variable range	Initial setting value
1	OSD POS.	000 — 007	002
2	CCD POS.	000 — 015	003
3	EOSEL	000 / 001	000
4	MENU COLOR	000 — -030	-010
5	MENU PICT.	000 — -030	-010
6	MENU BRI.	000 — -030	-010

● PIP MODE

No.	Setting (Adjustment) item	Variable range	Initial setting value
1	PIP BR	000 — 015	005
2	PIP PICT	030 — 045	045
3	PIP TINT	000 — 063	036
4	PIP COL	000 — 015	010
5	P R CUT	000 — 015	003
6	P G CUT	000 — 015	000
7	P B CUT	000 — 015	002
8	P R DR	000 — 255	052
9	P G DR	000 — 255	055
10	P B DR	000 — 255	060
11	LEFT POS.	000 — 255	020
12	RIGHT POS.	000 — 255	017
13	UPPER POS.	000 — 127	012
14	LOWER POS.	000 — 127	011
15	PICT LOCK	000 / 001	001
16	SELDEL	000 — 015	000
17	AGCFIX	000 / 001	001
18	AGCADST	000 / 001	000
19	AGC	000 — 015	007
20	VSPDEL	000 — 031	000
21	VSPISQ	000 / 001	001
22	YCOR	000 / 001	001
23	XFREQF	000 / 001	001
24	WTCHDG	000 / 001	001
25	COLON	000 / 001	000
26	ACQNEW	000 / 001	000
27	DSTDET	000 / 001	001
28	CRIBEOK	000 / 001	000
29	FCBEOK	000 / 001	000
30	NOCRID	000 / 001	000
31	NONSED	000 / 001	000

● **LOW LIGHT MODE**

Setting (Adjustment) item	Variable range	Initial setting value
R CUTOFF	0 — 255	085
G CUTOFF	0 — 255	085
B CUTOFF	0 — 255	085

● **HIGH LIGHT MODE**

Setting (Adjustment) item	Variable range	Initial setting value
R DRIVE	0 — 127	060
B DRIVE	0 — 127	060

● **RF AFC1 MODE**

Setting (Adjustment) item	Variable range	Initial setting value
RF AFC1	ON / OFF	ON
FINE	-77 — +77	± × × ( DO NOT ADJUST )

● **RF AFC2 MODE**

Setting (Adjustment) item	Variable range	Initial setting value
RF AFC2	ON / OFF	ON
FINE	-77 — +77	± × × ( DO NOT ADJUST )

● **I2C BUS CTRL MODE**

Setting (Adjustment) item	Variable range	Initial setting value
I2C BUS	ON/OFF	[FIXED ON] ( DO NOT ADJUST )

## ADJUSTMENTS

### B1 POWER SUPPLY

Item	Measuring instrument	Test point	Adjustment part	Description
Check of B1 POWER SUPPLY	DC Voltmeter	R507 C504 side (B1)  Q511 heatsink (77)		<ol style="list-style-type: none"> <li>1. Receive a black-and-white signal.</li> <li>2. Connect the DC Voltmeter to R507 C504 side (B1) and Q511 heatsink (77).</li> <li>3. Confirm that the voltage is DC134V <math>\begin{matrix} +2V \\ -2V \end{matrix}</math>.</li> </ol>

### ADJUSTMENT OF RF AGC

Item	Measuring instrument	Test point	Adjustment part	Description
RF AGC adjustment			No.59 RF AGC	<ol style="list-style-type: none"> <li>1. Receive a broadcast.</li> <li>2. Select the No.59 RF AGC of the PICTURE MODE.</li> <li>3. Press the MUTE key of the remote control unit and turn off color.</li> <li>4. With the LEFT key of the remote control unit, get noise in the screen picture. (0 side of setting value)</li> <li>5. Press the RIGHT key of the remote control unit and stop when noise disappears from the screen.</li> <li>6. Change to other channels and make sure that there is no irregularity.</li> <li>7. Press the MUTE key and get color out.</li> </ol>

### ADJUSTMENT OF FOCUS

Item	Measuring instrument	Test point	Adjustment part	Description
FOCUS adjustment	Signal generator		FOCUS VR [In HVT]  H VR [In HVT]	<p><b>Notes:</b></p> <ul style="list-style-type: none"> <li>• Proceed to the following this adjustment after having completed the adjustments of B1 POWER SUPPLY, SUB BRIGHT and PICTURE.</li> <li>• Set VIDEO STATUS to "STANDARD".</li> <li>• The final adjustment of convergence must be done after the FOCUS adjustment. (Convergence is changed by FOCUS adjustment.)</li> </ul> <ol style="list-style-type: none"> <li>1. Receive a crosshatch signal.</li> <li>2. While looking at the screen center, adjust the FOCUS VR so that the horizontal lines will be clear and in fine detail.</li> <li>3. Adjust the H VR so that the vertical lines will be clear and in fine detail.</li> <li>4. Make sure that the picture is in focus even when the screen gets darkened.</li> </ol>

**ADJUSTMENT OF WHITE BALANCE**

Item	Measuring instrument	Test point	Adjustment part	Description
<p><b>WHITE BALANCE (Low Light) Adjustment</b></p>	<p>Signal generator</p>		<p>No.1 BRIGHT R CUTOFF G CUTOFF B CUTOFF  SCREEN VR [In HVT]</p>	<p><b>Note :</b> Set VIDEO STATUS to "STANDARD".</p> <ol style="list-style-type: none"> <li>1. Receive a black-and-white signal.(Color off)</li> <li>2. Select the [LOW LIGHT] MODE from the SERVICE MENU.</li> <li>3. Set the initial setting value of BRIGHT is 063 with the LEFT / RIGHT key of the remote control unit.</li> <li>4. Set the initial setting value of R CUTOFF, G CUTOFF and B CUTOFF is 085 with the (4) to (9) key of the remote control unit.</li> <li>5. Display a single horizontal line by pressing the (1) key of the remote control unit.</li> <li>6. Turn the screen VR all the way to the left.</li> <li>7. Turn the screen VR gradually to the right from the left until either one of the red, blue or green colors appears faintly.</li> <li>8. Adjust the two colors which did not appear until the single horizontal line that is displayed becomes white using the (4) to (9) keys of the remote control unit.</li> <li>9. Turn the screen VR to where the single horizontal line glows faintly.</li> <li>10. Press the (2) key to return to the regular screen.</li> </ol> <p>* The (3) EXIT key is the cancel key for the WHITE BALANCE.</p>
<p><b>WHITE BALANCE (High Light) Adjustment</b></p>	<p>Signal generator</p>		<p>R DRIVE B DRIVE</p>	<p><b>Notes:</b></p> <ul style="list-style-type: none"> <li>• Proceed to the following this adjustment after having completed the adjustment of LOW LIGHT WHITE BALANCE.</li> <li>• Set VIDEO STATUS to "STANDARD".</li> </ul> <ol style="list-style-type: none"> <li>1. Receive a black-and-white signal. (Color off)</li> <li>2. Select the [HIGH LIGHT] MODE from the SERVICE MENU.</li> <li>3. Set the initial setting value of R DRIVE and B DRIVE is 060 with the (4), (6), (7) and (9) keys of the remote control unit.</li> <li>4. Adjust the screen until it becomes white using the (4), (6), (7) and (9) keys of the remote control unit.</li> </ol> <p>* The (3) (EXIT) key is the cancel key for the WHITE BALANCE.</p>

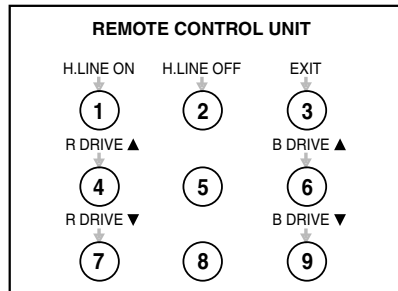
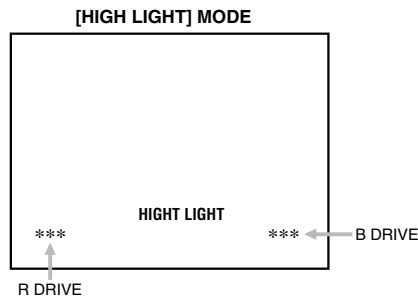
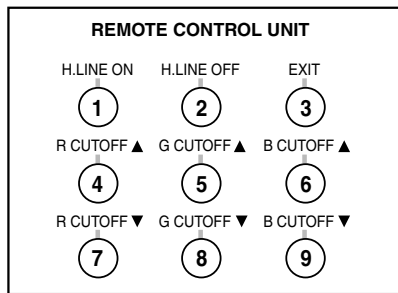
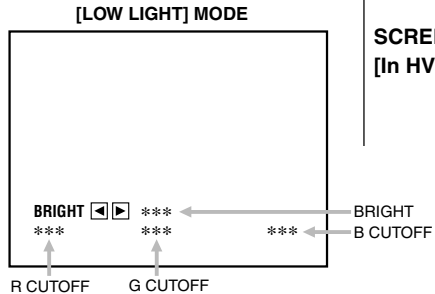



Item	Measuring instrument	Test point	Adjustment part	Description
<b>PIP HIGH LIGHT WHITE BALANCE</b>	<b>Signal generator</b>		<b>No.8 P R DR No.10 P B DR</b>	<p><b>Notes:</b></p> <ul style="list-style-type: none"> <li>• Proceed to the following this adjustment after having completed the adjustments of LOW LIGHT WHITE BALANCE and HIGH LIGHT WHITE BALANCE for the main picture.</li> <li>• Set VIDEO STATUS to "STANDARD".</li> </ul> <ol style="list-style-type: none"> <li>1. Receive a black-and-white signal. (Color off)</li> <li>2. Select the PIP MODE from the SERVICE MENU.</li> <li>3. Then adjust the white color of the PIP screen using the No. 8 P R DR and the No. 10 P B DR of the PIP MODE so that it is the same brightness as the main screen.</li> </ol>

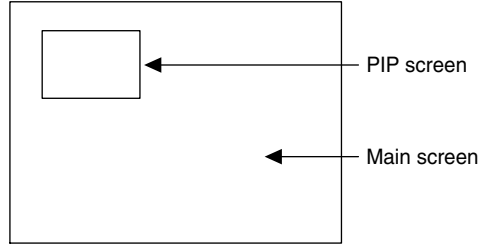

### ADJUSTMENT OF BRIGHT

Item	Measuring instrument	Test point	Adjustment part	Description
<b>SUB BRIGHT Adjustment</b>			<b>No.1 BRIGHT</b>	<p><b>Notes:</b></p> <ul style="list-style-type: none"> <li>• Proceed to the following this adjustment after having completed the adjustments of LOW LIGHT WHITE BALANCE and HIGH LIGHT WHITE BALANCE.</li> <li>• Set VIDEO STATUS to "STANDARD".</li> </ul> <ol style="list-style-type: none"> <li>1. Receive a broadcast.</li> <li>2. Select the No.1 BRIGHT of the PICTURE MODE.</li> <li>3. Set the initial setting value of the No.1 BRIGHT with the LEFT / RIGHT key of the remote control unit.</li> <li>4. If the brightness is not best with the initial setting value, make fine adjustment of the No.1 BRIGHT until you get the optimum brightness.</li> </ol>

### ADJUSTMENT OF CONTRAST

Item	Measuring instrument	Test point	Adjustment part	Description
<b>SUB CONTRAST Adjustment</b>			<b>No.2 PICTURE</b>	<p><b>Notes:</b></p> <ul style="list-style-type: none"> <li>• Proceed to the following this adjustment after having completed the adjustment of SUB BRIGHT.</li> <li>• Set VIDEO STATUS to "STANDARD".</li> </ul> <ol style="list-style-type: none"> <li>1. Receive a broadcast.</li> <li>2. Select the No.2 PICTURE of the PICTURE MODE.</li> <li>3. Set the initial setting value of the No.2 PICTURE with the LEFT / RIGHT key of the remote control unit.</li> <li>4. If the contrast is not best with the initial setting value, make fine adjustment of the No.2 PICTURE until you get the optimum contrast.</li> </ol>

**ADJUSTMENT OF DEFLECTION**

Item	Measuring instrument	Test point	Adjustment part	Description
<p><b>V CENTER and TRAPEZIUM Adjustment</b></p>	<p>Signal generator</p>		<p>No.68 V CENTER No.78 TRAPEZ</p>	<p><b>Note:</b> Proceed to the following this adjustment after having completed the adjustments of SUB BRIGHT and SUB CONTRAST.</p> <ol style="list-style-type: none"> <li>1. Receive a crosshatch signal.</li> <li>2. Adjust the No.68 V CENTER of the PICTURE MODE to be the same between the CRT vertical center and crosshatch vertical center.</li> <li>3. Adjust the No.78 TRAPEZ of the PICTUER MODE to be the vertical lines straight.</li> <li>4. Confirm the vertical lines to be straight. If it is not straight, adjust to be straight at the No.78 TRAPEZ.</li> </ol>
<p><b>V-SIZE and V-LINEARITY Adjustment</b></p>	<p>Signal generator</p>		<p>No.66 V SIZE No.65 V LIN</p>	<p><b>Note:</b> Proceed to the following this adjustment after having completed the adjustments of SUB BRIGHT and SUB CONTRAST.</p> <ol style="list-style-type: none"> <li>1. Receive a crosshatch signal.</li> <li>2. Select the No.66 V SIZE of the PICTURE MODE to squeeze the laster.</li> <li>3. Adjust the No.65 V LIN of the PICTURE MODE to be symmetrical.</li> <li>4. Adjust the No.66 V SIZE until the vertical screen size is 90%.</li> </ol>
<p><b>H POSITION Adjustment</b></p>	<p>Signal generator</p>		<p>No.72 H POSI</p>	<p><b>Note:</b> Proceed to the following this adjustment after having completed the adjustments of FOCUS, SUB BRIGHT, SUB CONTRAST, V CENTER, TRAPEZIUM, V-SIZE and V-LINEARITY.</p> <ol style="list-style-type: none"> <li>1. Receive a crosshatch signal.</li> <li>2. Select the No.72 H POSI of the PICTURE MODE.</li> <li>3. Adjust the No.72 H POSI until the screen will be horizontally centered.</li> </ol>
<p><b>PIP DISPLAY POSITION Adjustment</b></p>			<p>No.11 LEFT POS. No.12 RIGHT POS. No.13 UPPER POS. No.14 LOWER POS.</p>	<p><b>Notes:</b></p> <ul style="list-style-type: none"> <li>•Proceed to the following this adjustment after having completed the adjustments of V CENTER, TRAPEZIUM, V-SIZE, V-LINEARITY and H POSITION for the main picture.</li> <li>•Set VIDEO STATUS to "STANDARD".</li> </ul> <ol style="list-style-type: none"> <li>1. Receive a broadcast.</li> <li>2. Select the PIP MODE from the SERVICE MENU.</li> <li>3. Then adjust the PIP screen size so that it occupies 80% ± 2% of the main screen area.</li> </ol>

**ADJUSTMENT OF CHROMA**

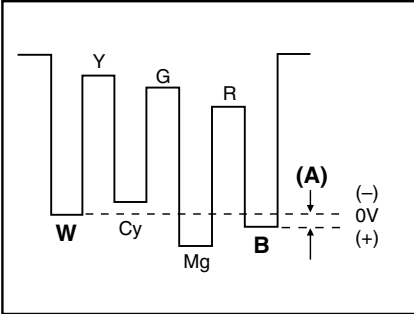
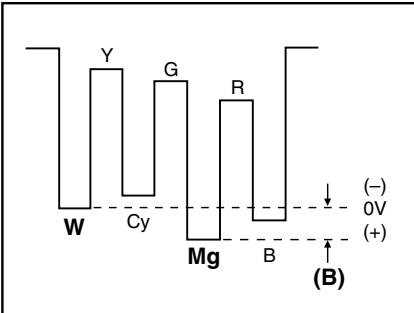
Item	Measuring instrument	Test point	Adjustment part	Description					
<p><b>SUB COLOR adjustment</b></p>	<p>Signal generator Oscilloscope Remote control unit</p>	<p>TP-B TP-E( <math>\overline{77}</math> ) [CRT SOCKET PWB]</p>	<p>No.3 COLOR</p>	<p><b>Notes:</b></p> <ul style="list-style-type: none"> <li>• Proceed to the following this adjustment after having completed the adjustment of CONTRAST.</li> <li>• Set VIDEO STATUS to "STANDARD".</li> </ul> <p><b>[ Method of adjustment without measuring instrument ]</b></p> <ol style="list-style-type: none"> <li>1. Receive a broadcast.</li> <li>2. Select the No.3 COLOR of the PICTURE MODE.</li> <li>3. Set the initial setting value of the No.3 COLOR with the LEFT/RIGHT key of the remote control unit.</li> <li>4. If the color is not the best with the Initial setting value, make fine adjustment of the No.3 COLOR until you get the optimum color.</li> </ol> <p><b>Notes:</b></p> <ul style="list-style-type: none"> <li>• Proceed to the following this adjustment after having completed the adjustment of CONTRAST.</li> <li>• Set VIDEO STATUS to "STANDARD".</li> </ul> <p><b>[ Method of adjustment using measuring instrument ]</b></p> <ol style="list-style-type: none"> <li>1. Input the full field color bar signal (75% white).</li> <li>2. Select the No.3 COLOR of the PICTURE MODE.</li> <li>3. Set the initial setting value of the No.3. COLOR with the LEFT/RIGHT key of the remote control unit.</li> <li>4. Connect the oscilloscope between TP-B and TP-E.</li> <li>5. Adjust COLOR and bring the value of (A) in the illustration to the voltage shown in the table 1.</li> </ol>					
<div style="text-align: center;">  <table border="1" data-bbox="464 905 777 982"> <thead> <tr> <th></th> <th>A (Vw-B)</th> </tr> </thead> <tbody> <tr> <td>AV-27D502/R</td> <td>+7V</td> </tr> <tr> <td>AV-27D502/s</td> <td>+4V</td> </tr> </tbody> </table> <p><b>Table 1</b></p> </div>					A (Vw-B)	AV-27D502/R	+7V	AV-27D502/s	+4V
	A (Vw-B)								
AV-27D502/R	+7V								
AV-27D502/s	+4V								
<p><b>SUB TINT adjustment</b></p>	<p>Signal generator Oscilloscope Remote control unit</p>	<p>TP-B TP-E( <math>\overline{77}</math> ) [CRT SOCKET PWB]</p>	<p>No.4 TINT</p>	<p><b>Notes:</b></p> <ul style="list-style-type: none"> <li>• Proceed to the following this adjustment after having completed the adjustment of CONTRAST.</li> <li>• Set VIDEO STATUS to "STANDARD".</li> </ul> <p><b>[ Method of adjustment without measuring instrument ]</b></p> <ol style="list-style-type: none"> <li>1. Receive a broadcast.</li> <li>2. Select the No.4 TINT of the PICTURE MODE.</li> <li>3. Set the initial setting value of the No.4 TINT with the LEFT/RIGHT key of the remote control unit.</li> <li>4. If the tint is not the best with the initial setting value, make fine adjustment of the No.4 TINT until you get the optimum tint.</li> </ol> <p><b>Notes:</b></p> <ul style="list-style-type: none"> <li>• Proceed to the following this adjustment after having completed the adjustment of CONTRAST.</li> <li>• Set VIDEO STATUS to "STANDARD".</li> </ul> <p><b>[ Method of adjustment using measuring instrument ]</b></p> <ol style="list-style-type: none"> <li>1. Input the full field color bar signal (75% white).</li> <li>2. Select the No.4 TINT of the PICTURE MODE.</li> <li>3. Set the initial setting value of the No.4 TINT with the LEFT/RIGHT key to the remote control unit.</li> <li>4. Connect the oscilloscope between TP-B and TP-E.</li> <li>5. Adjust TINT and bring the value of (B) in the illustration to the voltage shown in the table 2.</li> </ol>					
<div style="text-align: center;">  <table border="1" data-bbox="464 1755 773 1833"> <thead> <tr> <th></th> <th>B (Vw-Mg)</th> </tr> </thead> <tbody> <tr> <td>AV-27D502/R</td> <td>+9V</td> </tr> <tr> <td>AV-27D502/s</td> <td>+5V</td> </tr> </tbody> </table> <p><b>Table 2</b></p> </div>					B (Vw-Mg)	AV-27D502/R	+9V	AV-27D502/s	+5V
	B (Vw-Mg)								
AV-27D502/R	+9V								
AV-27D502/s	+5V								

## ADJUSTMENT OF MTS CIRCUIT

Item	Measuring instrument	Test point	Adjustment part	Description
MTS INPUT LEVEL check			No.2 IN LEVEL	<ol style="list-style-type: none"> <li>Select the No.2 IN LEVEL of the SOUND MODE.</li> <li>Verify that the No.2 IN LEVEL is set at its initial setting value.</li> </ol>
MTS STEREO VCO adjustment	Signal generator  Frequency counter	[MPX] Connector 2 pin AUDIO R 3 pin GND	No.3 FH MONITOR  No.4 STEREO VCO	<p><b>Note:</b> Menu "MTS" is set to "STEREO"</p> <ol style="list-style-type: none"> <li>Receive a RF signal (nonmodulated sound signal) from the antenna terminal.</li> <li>Select the No.3 FH MONITOR of SOUND MODE, and change the setting value from 0 to 1.</li> <li>Connect the Frequency Counter to pin 2 of [MPX] connector and GND (Pin 3 of [MPX] connector).</li> <li>Select the No.4 STEREO VCO.</li> <li>Set the initial setting value of the No.4 STEREO VCO with the LEFT/RIGHT key of the remote control unit.</li> <li>Adjust the No.4 STEREO VCO so that the frequency counter will display <math>15.73\text{kHz} \pm 0.1\text{kHz}</math>.</li> <li>Select the No.3 FH MONITOR of the SOUND MODE, and reset the setting value from 1 to 0.</li> </ol>
MTS SAP VCO adjustment	Signal generator  Frequency counter	[MPX] Connector 4 pin TP_952.5 3 pin GND 2 pin AUDIO_R	No.9 5FH MON.  No.10 SAP VCO	<ol style="list-style-type: none"> <li>Receive a RF signal (non modulated sound signal) from the antenna terminal.</li> <li>Connect between pin 4 of [MPX] connector and GND (Pin 3 of [MPX] connector) through <math>1\text{M}\Omega</math> Resistor.</li> <li>Select the No.9 5FH MON. of the SOUND MODE, and reset the setting value from 0 to 1.</li> <li>Connect the Frequency Counter to pin 2 of [MPX] connector and GND (Pin 3 of [MPX] connector) .</li> <li>Select the No.10 SAP VCO.</li> <li>Set the initial setting value of the No.10 SAP VCO with the LEFT/RIGHT key of the remote control unit.</li> <li>Adjust the No.10 SAP VCO so that the frequency counter will display <math>78.67\text{kHz} \pm 0.5\text{kHz}</math>.</li> <li>Select the No.9 5FH MON. of the SOUND MODE, and reset the setting value from 1 to 0.</li> </ol>
MTS FILTER check			No.6 FILTER	<ol style="list-style-type: none"> <li>Select the No.6 FILTER of the SOUND MODE.</li> <li>Verify that the No.6 FILTER is set at its initial setting value.</li> </ol>
MTS SEPARATION adjustment	TV audio multiplex signal generator  Oscilloscope	[MPX] Connector 1 pin AUDIO_L 2 pin AUDIO_R 3 pin GND	No.7 LOW SEP.  No.8 HI SEP.	<p><b>Note:</b> Menu "MTS" is set to "STEREO"</p> <ol style="list-style-type: none"> <li>Input a stereo L signal (300Hz) from the TV audio multiplex signal generator to the antenna terminal.</li> <li>Connect an oscilloscope to pin 1 of [MPX] connector, and display one cycle portion of the 300Hz signal.</li> <li>Change the connection of the oscilloscope to pin 2 of [MPX] connector, and enlarge the voltage axis.</li> <li>Select the No.7 LOW SEP. of the SOUND MODE.</li> <li>Set the initial setting value of the No.7 LOW SEP. with the LEFT/RIGHT key of the remote control unit.</li> <li>Adjust the No.7 LOW SEP. so that the 300Hz signal level will become minimum.</li> <li>Change the signal to 3kHz, and connect an oscilloscope to pin 1 of [MPX] connector.</li> <li>Adjust the No.8 HI SEP. so that the 3kHz signal level will become minimum.</li> </ol>

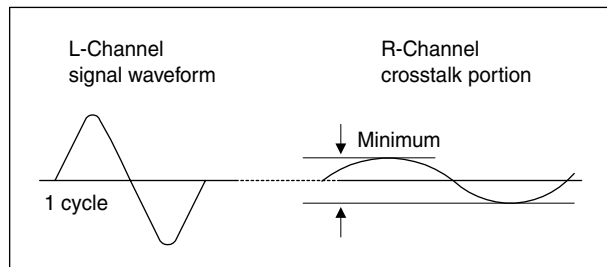

# HOW TO CHECK THE HIGH VOLTAGE HOLD DOWN CIRCUIT

## 1. HIGH VOLTAGE HOLD DOWN CIRCUIT

After repairing the high voltage hold down circuit shown in Fig. 1.  
This circuit shall be checked to operate correctly.

## 2. CHECKING OF THE HIGH VOLTAGE HOLD DOWN CIRCUIT

- (1) Turn the POWER SW ON.
- (2) As shown in Fig. 1, set the resistor (between **S1** connector **2** & **3** ).
- (3) Make sure that the screen picture disappears.
- (4) Temporarily unplug the power cord.
- (5) Remove the resistor (between **S1** connector **2** & **3** ).
- (6) Again plug the power cord, make sure that the normal picture is displayed on the screen.

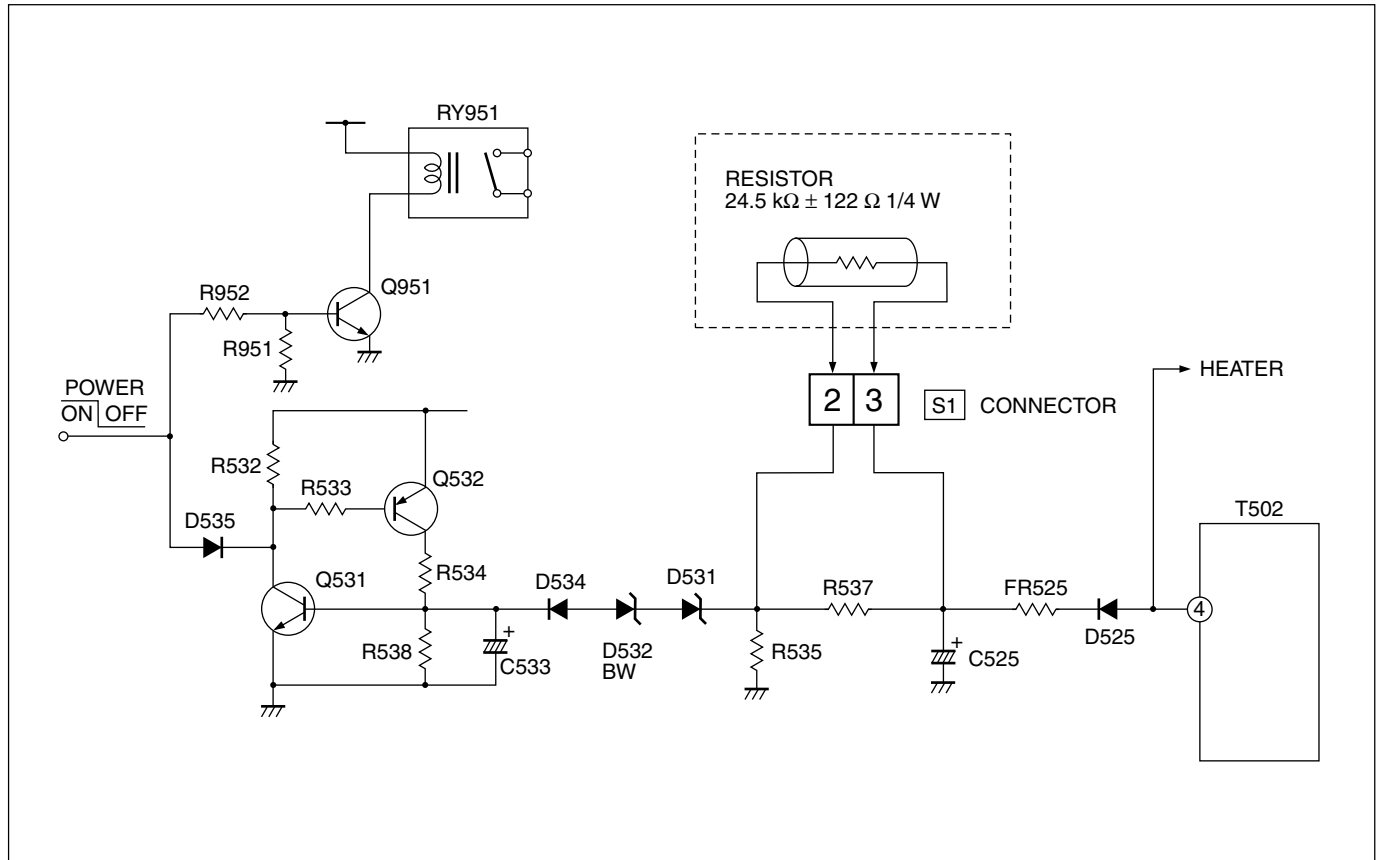

Fig. 1

# SELF CHECK FUNCTIONS

## 1. Outline

This model has self check functions given below. When a malfunction has been detected, the POWER is turned off and the LED flashes to inform of the failure . The malfunction is detected by the signal input state of the control line connected to the microcomputer.

## 2. Self check items

Check item	Details of detection	Method of detection	State of malfunction
Over-current protector	Operation of B1 protector circuit.	The microcomputer detects at 1 second intervals. If NG is detected for more than 200 ms, a malfunction is interpreted.	When a malfunction has been detected, the POWER is turned off. While the POWER is being turned off , the power key of the remote controller is not operational until the power code is taken out and put in again.

## 3. Self check indicating function

The self-check function begins detection about 5 seconds after power is supplied.

In the event a malfunction is detected, the power is cut off immediately.

At this time, the ON-TIMER LED flashes to inform of the malfunction.

### [ON-TIMER LED indication]

The ON-TIMER LED flashes at 0.5 seconds intervals.

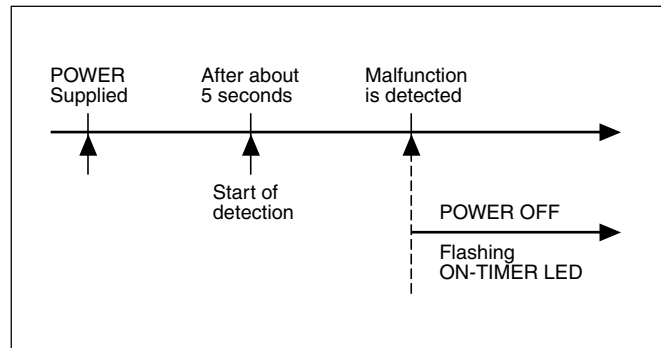

# JVC SERVICE & ENGINEERING COMPANY OF AMERICA

## DIVISION OF JVC AMERICAS CORP.

<b>Head office</b>	: 1700 Valley Road, Wayne, New Jersey 07470	(973)315-5000
<b>East Coast</b>	: 10 New Maple Avenue, Pine Brook, New Jersey 07058	(973)396-1000
<b>Midwest</b>	: 705 Enterprise St. Aurora, Illinois 60504	(630)851-7855
<b>West Coast</b>	: 5665 Corporate Avenue, Cypress, California 90630	(714)229-8011
<b>Southwest</b>	: 10700 Hammerly, Suite 105, Houston, Texas 77043	(713)935-9331
<b>Hawaii</b>	: 2969 Mapunapuna Place, Honolulu, Hawaii 96819	(808)833-5828
<b>Southeast</b>	: 1500 Lakes Parkway, Lawrenceville, Georgia 30243	(770)339-2582

## JVC CANADA INC.

<b>Head office</b>	: 21 Finchdene Square Scarborough, Ontario M1X 1A7	(416)293-1311
<b>Vancouver</b>	: 13040 Worster Court Richmond B.C. V6V 2B3	(604)270-1311

# JVC®